

# LINEAR COMPONENTS

## Table of Contents

### HIGH PRECISION AND PRECISION LEAD SCREWS

Technical Data .....	ME 2
Anti-Backlash Lead Screw Assemblies .....	ME 3
Lead Screws .....	ME 4

### LINEAR SLIDES

Technical Data Linear Slides .....	ME 5
Cross Roller Slides .....	ME 6
Linear Ball Slides .....	ME 7
Cross Roller Lead Screw Driven Slide .....	ME 8 - ME 9
Rack Driven Ball Slides .....	ME 10
Rack Driven Ball Slide Pinions .....	ME 11

### LINEAR BEARINGS

Flanged Type .....	ME 12
Ball Bearings .....	ME 13 - ME 14, ME 16
Self-Aligning - Barrel Style .....	ME 15
No Lube .....	ME 17

### GROUND SHAFTING

Shaft Seals .....	ME 18
-------------------	-------

*For inch options, please see our inch catalog.*

# HIGH PRECISION & PRECISION LEAD SCREWS

## Design Considerations

**Critical Speed** - The critical speed of a lead screw shaft is the maximum speed (rpm) before the screw will become dynamically unstable. This results when the forced frequency of the rotating screw corresponds to its natural frequency. It's value is dependent on the length of the screw, the diameter of the thread, and the support configuration. The critical speed value is governed by the following equation.

$$\text{Critical Screw Speed (N)} = K \times C \times 10^6 \times d/D^2$$

Where:

K = End support factor

- 0.36 one end fixed, other free (Figure 9.1)
- 1.00 simple supports both ends (Figure 9.2)
- 1.47 one end fixed, one simple (Figure 9.3)
- 2.23 both ends fixed (Figure 9.4)

C = Material factor

4.5 for Stainless Steel screws

1.6 for Aluminum screws

d = Root diameter of the screw

D = Distance between the nut and the support bearing

**Load** - In order to properly incorporate a lead screw into a design, load requirements must be taken into account. Maximum load values for the nuts are listed in the tables on the following pages. These numbers are based on the shear of the nuts and does not take shaft buckling into account (see Max. Column Load formula below). Wherever possible, nuts should be positioned so as to be put in tension, pulling the load. This eliminates the need for buckling considerations. Listed below are some helpful formulas to assist in proper lead screw selection.

$$\text{Max. Critical Column Load (F)} = K \times C \times 10^6 \times d^4/D^2$$

Where:

K = End support factor

- 0.25 one end fixed, other free (Figure 9.1)
- 1.00 simple supports both ends (Figure 9.2)
- 2.00 one end fixed, one simple (Figure 9.3)
- 4.00 both ends fixed (Figure 9.4)

C = Material factor

13.4 for Stainless Steel screws

4.8 for Aluminum screws

d = Root diameter of the screw

D = Distance between the nut and the support bearing

$$\text{Torque to Move a Load (T)} = F \times L/2 \times \xi \times E$$

Where:

F = Load

L = Lead

E = Efficiency (consult Berg Engineering Department for efficiency values)



Figure 9.1



Figure 9.2



Figure 9.3



Figure 9.4

# ANTI-BACKLASH LEAD SCREW ASSEMBLIES

SERIES	MATERIAL
<b>HIGH PRECISION</b>	<b>NUT - ACETAL, SPRING - STEEL PLATED ZINC, SCREW - STAINLESS STEEL (400 SERIES)</b>

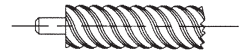
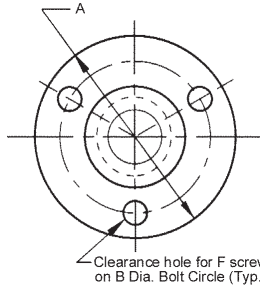
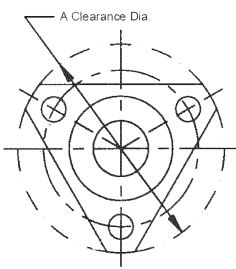
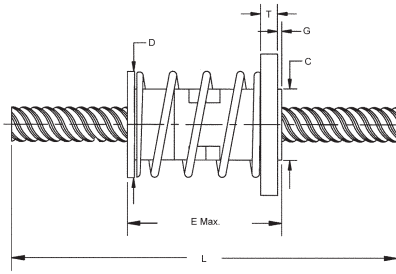

Special end configurations available on request.

D

## Helitronic Thread

STOCK NO.	PITCH DIA.	LEAD	ØA	ØB	ØC	ØD	E	G	T	F	L
TTMS4ABS1-300	4	1	25.5	19	11	15	29	1.5	5	M3	300
TTMS6ABS2-300	6	2									
TTMS8ABS4-300	8	4									
TTMS10ABS2-500	10	2	38	32	16	19	38	1.5	5	M3	500
TTMS10ABS20-500	10	20									
TTMS12ABS5-500	12	5									
TTMS12ABS10-500	12	10									
TTMS16ABS4-1000	16	4	44.5	35	22.5	26	53	2	6.5	M4	1000
TTMS16ABS10-1000	16	10									
TTMS20ABS4-1000	20	4	55.5	45.50	30	40	63.5	2	6.5	M5	1000
TTMS20ABS10-1000	20	10									
TTMS20ABS20-1000	20	20									
TTMS25ABS5-1000	25	5									
TTMS25ABS10-1000	25	10									
TTMS25ABS20-1000	25	20									

Additional nuts, other lengths and materials are available, call for quotes.

# PRECISION LEAD SCREWS

## MATERIAL

**NUT - ACETAL    SCREW - HIGH HELIX THREAD, ALUMINUM ANODIZED  
HELITRONIC THREAD, STAINLESS STEEL (400 SERIES)**

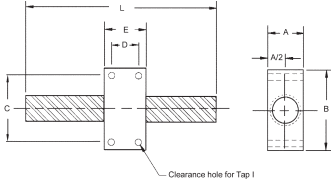

**LEAD SCREW WITH RECTANGULAR NUT**

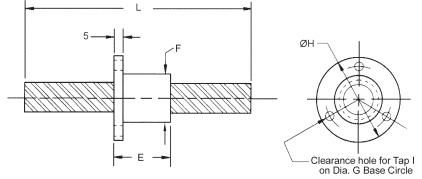

**LEAD SCREW WITH ROUND NUT**

### Rectangular Nut

HELITRONIC THREAD STOCK NO.	HELIX THREAD STOCK NO.	PITCH DIA.	LEAD	A	B	C	D	E	ØF	ØG¹	ØH	I¹	L
TTM4KS1-300	-	4	1										
-	HTM5KA10-300	5	10										
-	HTM5KA15-300	5	15	12.5	33	25	*	19	12	20	28	M3	300
TTM6KS2-300	-	6	2										
TTM8KS4-300	-	8	4										
TTM10KS2-500	-	10	2										
TTM10KS20-500	HTM10KA20-500	10	20	16	44.5	35	*	19	16	25	35	M4	500
-	HTM10KA30-500	10	30										
TTM12K-500	-	12	5										
TTM12KS10-500	-	12	10	19	50	40	15.5	25	20	30¹	40	M¹	500
TTM16KS4-1000	-	16	4										
TTM16KS10-1000	-	16	10	25	50	40	15.5	25	25	35	45	M4	1000
TTM20K-1000	-	20	4										
TTM20KS10-1000	-	20	10										
TTM20KS20-1000	-	20	20	35	60	50	20	30	30	40	50	M5	1000
-	HTM20KA40-1000	20	40										
-	HTM20KA60-1000	20	60										
TTM25KS5-1000	-	25	5										
TTM25KS10-1000	-	25	10										
TTM25KS20-1000	-	25	20	35	60	50	20	30	35	45	55	M5	1000
-	HTM25KA50-1000	25	50										
-	HTM25KA75-1000	25	75										

### Round Nut

HELITRONIC THREAD STOCK NO.	HELIX THREAD STOCK NO.	PITCH DIA.	LEAD	A	B	C	D	E	ØF	ØG¹	ØH	I¹	L
TTM4LS1-300	-	4	1										
-	HTM5LA10-300	5	10										
-	HTM5LA15-300	5	15	12.5	33	25	*	19	12	20	28	M3	300
TTM6LS2-300	-	6	2										
TTM8LS4-300	-	8	4										
TTM10LS2-500	-	10	2										
TTM10LS20-500	HTM10LA20-500	10	20	16	44.5	35	*	19	16	25	35	M4	500
-	HTM10LA30-500	10	30										
TTM12K-500	-	12	5										
TTM12LS10-500	-	12	10	19	50	40	15.5	25	20	30¹	40	M4¹	500
TTM16LS4-1000	-	16	4										
TTM16LS10-1000	-	16	10	25	50	40	15.5	25	25	35	45	M4	1000
TTM20K-1000	-	20	4										
TTM20LS10-1000	-	20	10										
TTM20LS20-1000	-	20	20	35	60	50	20	30	30	40	50	M5	1000
-	HTM20LA40-1000	20	40										
-	HTM20LA60-1000	20	60										
TTM25LS5-1000	-	25	5										
TTM25LS10-1000	-	25	10										
TTM25LS20-1000	-	25	20	35	60	50	20	30	35	45	55	M5	1000
-	HTM25LA50-1000	25	50										
-	HTM25LA75-1000	25	75										

#### NOTE:

Special lengths, ends or diameters and additional nuts available on request.

\* These items are supplied with one mounting hole at E/2, on each side.

¹ These holes / bolt circles may be slotted to accept a range of sizes.

# LINEAR SLIDES

## TECHNICAL DATA

W. M. Berg, Inc. manufactures a complete line of off the shelf linear ball slides and linear crossed roller slide bearings. Made to the highest quality standards, components must pass strict inspection requirements at each stage of manufacturing. These Quality Control steps ensure precise, uniform, linear movement with low friction and minimum side-play.

Available in inch or metric sizes, and in travel lengths ranging from 12mm to 600mm, slides have flat, parallel, and smooth mounting surfaces. Equipped with mounting holes, they are shipped ready to install, with no need for modifications or adjustments.

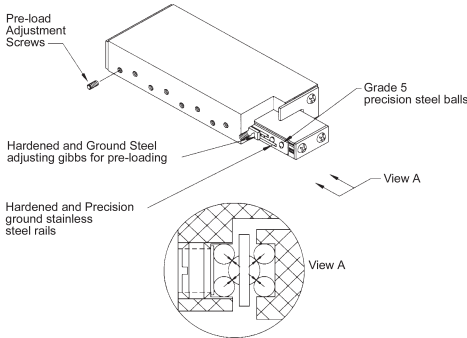

FIGURE 1

### Linear Ball Slides

**W. M. Berg Inc.** Linear Ball Slides are designed to provide precise linear movement for **light to medium loads**. Their construction, as shown in Figure 1, consists of precision Grade 5 balls rolling along ground wire ways. Since the rolling contact surface is a point, the bearing ways are self cleaning, expelling matter which may deposit on their surfaces.

### Linear Crossed Roller Slides

W. M. Berg Inc. Linear Crossed Roller Slides are designed to provide precise linear movement for medium to heavy loads. Their improved stiffness and rigidity mean long term reliability under the punishment of vibration and shock conditions. Their construction as shown in Figure 2 consists of precision rollers rolling along ground flat ways. Since the rolling contact surface is a line, they can support greater loads than the ball slides

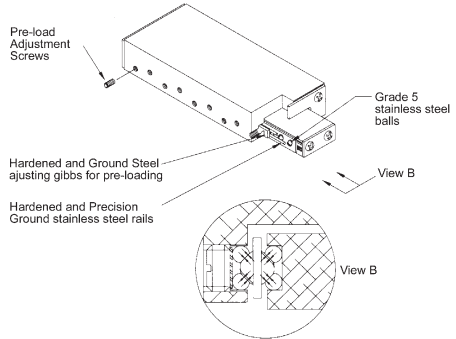

FIGURE 2

- Straightness of Travel = Precision Series - 0.0127mm/mm  
\* Ultra-precision Series - 0.0101mm/mm
- Repeatability of Travel = Precision Series - 0.254 mm  
Ultra-precision Series - 0.00127 mm
- Life =  $2.5 \times 10^8$ mm of Travel at Safe Load Capacity  
=  $2.5 \times 10^9$ mm of Travel at 1/2 Safe Load Capacity
- Coefficient of Friction = .003

$$\text{Safe Load Capacity} = \frac{\text{Rated Load Capacity}}{\text{Safety Factor (SF)}}$$

\* Inspection Report Available for This Accuracy

# CROSS ROLLER SLIDES

TRAVEL	MATERIAL
<b>13.0mm TO 152.4mm</b>	<b>ALUMINUM BLACK ANODIZED</b>

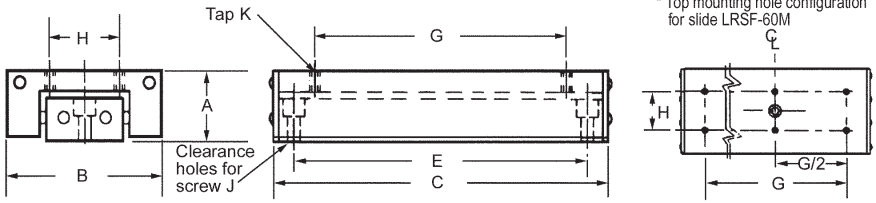

STOCK NO.	TRAVEL	A	B	C	E	G	H	J	RATED CAPACITY (kg)
LRSA-5M	13.0			26.9	19.0	16.0			15
LRSA-10M	25.5	8.0	14.0	52.3	35.0	41.5	5.5	M2.0 X 0.4	25
LRSA-20M	51.0			77.7	60.5	66.5			31
LRSB-5M	13.0			26.9	19.0	16.0			23
LRSB-10M	25.5	10.0	19.0	52.3	35.0	41.5	9.5	M3.0 X 0.5	36
LRSB-20M	51.0			77.7	60.5	66.5			45
LRSC-15M	38.1			65.0	54.0	57.0			61
LRSC-20M	50.8	13.5	27.0	90.4	79.5	82.5	11.0	M4.0 X 0.7	102
LRSC-30M	76.2			115.8	82.5	101.5			120
LRSD-10M	25.4			50.8	36.0	35.0			61
LRSD 20M	50.8	16.0	38.0	76.2	63.5	60.5	16.0	M4.0 X 0.7	82
LRSD 30M	76.2			101.6	89.0	85.5			82
LRSD-40M	101.6			152.4	101.5	136.5			141
LRSE-10M	25.4			50.8	41.5	35.0			82
LRSE-20M	50.8	19.1	44.5	82.6	70.0	66.5	22.0	M4.0 X 0.7	82
LRSE 30M	76.2			101.6	89.0	85.5			109
LRSE-40M	101.6			152.4	101.5	139.5			141
LRSF-15M	38.1			66.5	47.5	41.5			150
LRSF-20M	50.8	25.5	66.5	101.5	85.5	76.0	32.0	M5.0 X 0.8	190
LRSF-30M	76.2			127.0	111.0	101.6			204
LRSF-40M	101.6			152.5	136.5	127.0			227
LRSF-60M*	152.4			228.5	178.0	152.4			320

Other sizes and load capacities available.

# LINEAR BALL SLIDES

TRAVEL	MATERIAL
12.0mm TO 200mm	ALUMINUM BLACK ANODIZED

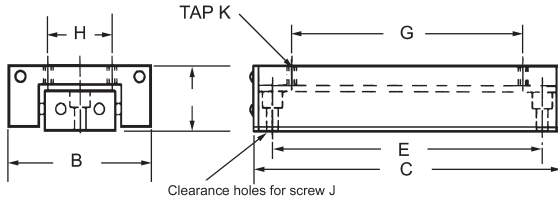

STOCK NO.	TRAVEL	A	B	C	E	G	H	J	K	RATED CAPACITY (kg)
LBSGM-12	12			20	10	10				1
LBSGM-25	25	6.0	9.5	32	20	20	4	M2 X 0.4*	M2 X 0.4	1
LBSGM-35	35			45	30	30				1
LBSKM-12	12			28	20	15				2
LBSKM-25	25			51	30	40				4
LBSKM-50	50	8.0	14.0	102	80	65	5	M2	M2 x 0.4	5
LBSKM-100	100			127	90	115				7
LBSKM-125	125			152	100	140				8
LBSEM-12	12			27	19	15				2
LBSEM-25	25			52	35	40				4
LBSEM-50	50	10.0	19.0	78	60	65	10	M3	M3 x 0.5	5
LBSEM-75	75			103	86	90				6
LBSEM-100	100			129	89	115				7
LBSEM-125	125			154	114	140				8
LBSFM-25	25			52	40	40				8
LBSFM-50	50			90	75	75				9
LBSFM-75	75	13.5	27.0	116	75	100	10	M4	M4 x 0.7	11
LBSFM-100	100			152	100	130				14
LBSFM-150	150			203	125	190				16
LBSFM-200	200			254	175	240				18
LBSHM-25	25			51	30	30				7
LBSHM-50	50			78	55	60				9
LBSHM-75	75	15.5	38.0	102	80	80	15	M4	M4 x 0.7	11
LBSHM-100	100			152	100	130				16
LBSHM-150	150			203	125	180				20
LBSHM-200	200			254	175	225				25
LBSAM-25	25			50	35	35				14
LBSAM-35	35	20.0	44.0	65	50	50	20	M5	M5 x 0.8	15
LBSAM-50	50			80	65	65				16
LBSAM-75	75			100	85	85				18
LBSBM-50	50			100	75	75				48
LBSBM-75	75	25.0	66.0	125	100	100	35	M5	M5 x 0.8	52
LBSBM-100	100			150	125	125				58

\* Tapped hole in this series only.

# ULTRA-PRECISION CROSS ROLLER LEAD SCREW DRIVEN SLIDE ASSEMBLIES

STYLE	TRAVEL	MATERIAL
<b>KNOB</b>	<b>25mm TO 150mm</b>	RAILS & ROLLERS - HARDENED AND GROUND TOOL STEEL TOP CARRIAGE 6061-T6 ALUMINUM, CLEAR ANODIZED OR G2 CLOSE GRAIN CAST IRON • RETAINERS BRASS

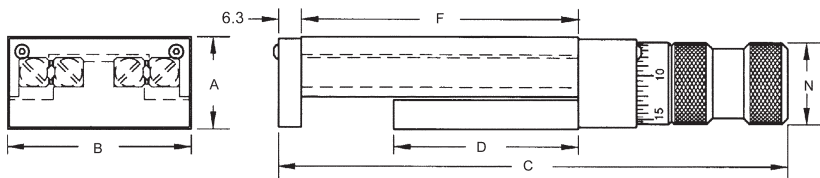

ALUMINUM STOCK NO.	CAST STOCK NO.	TRAVEL	A	B	C	D	F	RATED CAPACITY (kg)	N
LDA-01K	LDS-01K	25	25.0	50.8	140	50.8	76.2	105	22.2
LDA-02K	LDS-02K	25			165	76.2	101.6	160	
LDA-03K	LDS-03K	50			190	101.6	152.4	210	
LDA-04K	LDS-04K	25	31.7	76.2	175	76.2	101.6	160	27.7
LDA-05K	LDS-05K	25			200	101.6	127.0	235	
LDA-06K	LDS-06K	50			225	101.6	152.4	210	
LDA-07K	LDS-07K	25	36.5	101.6	225	127.0	152.4	290	34.9
LDA-08K	LDS-08K	60			276	152.4	203.2	340	
LDA-09K	LDS-09K	50			327	203.2	254.0	475	
LDA-10K	LDS-10K	75			378	228.6	304.8	500	
LDA-11K	LDS-11K	50	50.8	152.4	269	152.4	203.2	545	34.9
LDA-12K	LDS-12K	100			390	203.2	304.8	650	
LDA-13K	LDS-13K	150			492	304.8	406.4	780	

Mounting holes can be supplied at an additional cost, contact Customer Service.

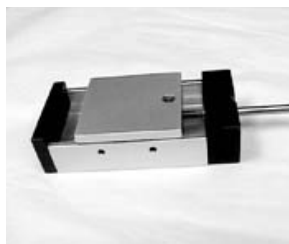



# ULTRA-PRECISION CROSS ROLLER LEAD SCREW DRIVEN SLIDE ASSEMBLIES

STYLE	TRAVEL	MATERIAL
<b>CRANK</b>	<b>25mm TO 150mm</b>	RAILS & ROLLERS - HARDENED AND GROUND TOOL STEEL TOP CARRIAGE 6061-T6 ALUMINUM, CLEAR ANODIZED OR G2 CLOSE GRAIN CAST IRON • RETAINERS BRASS

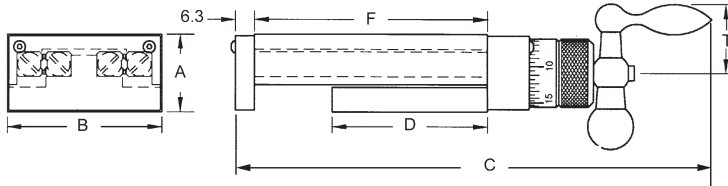

ALUMINUM STOCK NO.	CAST STOCK NO.	TRAVEL	A	B	C	D	F	N	RATED CAPACITY (kg)
LDA-01C	LDS-01C	25			155	50.8	76.2		105
LDA-02C	LDS-02C	25	25.0	50.8	180	76.2	101.6	25	160
LDA-03C	LDS-03C	50			206	101.6	152.4		210
LDA-04C	LDS-04C	25			184	76.2	101.6		160
LDA-05C	LDS-05C	25	31.7	76.2	210	101.6	127.0	25	235
LDA-06C	LDS-06C	50			235	101.6	152.4		210
LDA-07C	LDS-07C	25			235	127.0	152.4		290
LDA-08C	LDS-08C	60			285	152.4	203.2		340
LDA-09C	LDS-09C	50	36.5	101.6	337	203.2	254.0	25	475
LDA-10C	LDS-10C	75			387	228.6	304.8		500
LDA-11C	LDS-11C	50			313	152.4	203.2		545
LDA-12C	LDS-12C	100	50.8	152.4	414	203.2	304.8	38	650
LDA-13C	LDS-13C	150			515	304.8	406.4		780

Mounting holes can be supplied at an additional cost, contact Customer Service.

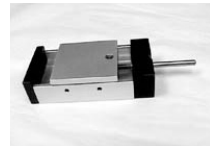

**D**

STYLE	TRAVEL	MATERIAL
<b>SHAFT</b>	<b>25mm TO 150mm</b>	RAILS & ROLLERS - HARDENED AND GROUND TOOL STEEL TOP CARRIAGE 6061-T6 ALUMINUM, CLEAR ANODIZED OR G2 CLOSE GRAIN CAST IRON • RETAINERS BRASS

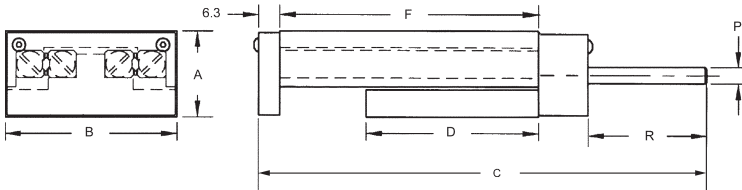

ALUMINUM STOCK NO.	CAST STOCK NO.	TRAVEL	A	B	C	D	F	P +0.005 +0.018	R	RATED CAPACITY (kg)
LDA-01SM	LDS-01SM	25			133	50.8	76.2			105
LDA-02SM	LDS-02SM	25	25.0	50.8	159	76.2	101.6	4.00	35	160
LDA-03SM	LDS-03SM	50			164	101.6	152.4			210
LDA-04SM	LDS-04SM	25			165	76.2	101.6			160
LDA-05SM	LDS-05SM	25	31.7	76.2	190	101.6	127.0	4.00	38	235
LDA-06SM	LDS-06SM	50			216	101.6	152.4			210
LDA-07SM	LDS-07SM	25			216	127.0	152.4			290
LDA-08SM	LDS-08SM	60			266	152.4	203.2			340
LDA-09SM	LDS-09SM	50	36.5	101.6	316	203.2	254.0	4.00	36	475
LDA-10SM	LDS-10SM	75			368	228.6	304.8			500
LDA-11SM	LDS-11SM	50			279	152.4	203.2			545
LDA-12SM	LDS-12SM	100	50.8	152.4	361	203.2	304.8	6.00	54	650
LDA-13SM	LDS-13SM	150			483	304.8	406.4			780

Mounting holes can be supplied at an additional cost, contact Customer Service.

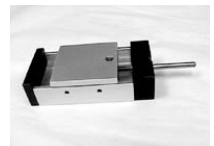

# RACK DRIVEN BALL SLIDES

TRAVEL	MATERIAL	PRESSURE ANGLE
<b>13mm TO 100mm</b>	<b>RACK - 416 STAINLESS STEEL BALL SLIDE - ANODIZED ALUMINUM</b>	<b>20°</b>

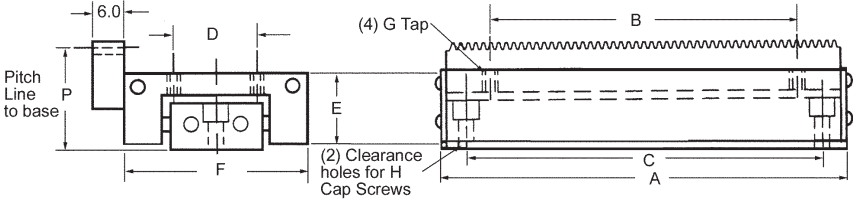

- Low starting and running friction
- Zero sideplay and wobble
- High accuracy and repeatability
- No lubrication required
- Heavy load carrying capacity
- Operates in any position
- Factory aligned and preloaded
- Easy replacement



STOCK NO.	MAX TRAVEL	MAX LOAD (kg)	A	B	C	D	E	F	G	H	P	MODULE
LRDB-5M	13	2.3	39.5	31.5	31.5							
LRDB-10M	25	4.5	65.0	57.0	57.0							
LRDB-15M	38	6.8	77.5	70.0	69.8	11.0	12.7	25.5	M3x0.5	M3	14.0	0.4
LRDB-20M	50	9.0	90.5	82.5	82.5							
LRDB-30M	75	13.6	116.0	108.0	108.0							
LRDD-10M	25	18.0	66.5	54.0	54.0							
LRDD-20M	50	27.0	101.6	76.2	85.5	31.5	25.4	66.5	M4X0.7	M4	28.0	0.8
LRDD-30M	75	40.7	127.0	101.6	111.0							
LRDD-40M	100	52.5	152.4	127.0	136.5							

Other sizes available on request.

# RACK DRIVEN BALL SLIDE PINIONS

MODULE	MATERIAL	PRESSURE ANGLE
0.4 AND 0.8	STAINLESS STEEL 1.4305	20°

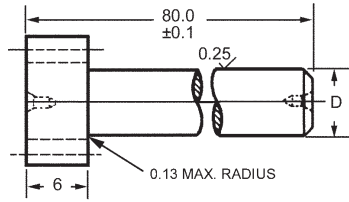
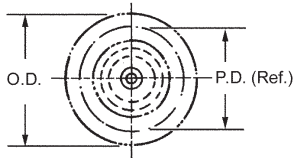

STOCK NO.	MODULE	NO. OF TEETH	P.D.	OD	D	USE FOR SLIDES
PSGS6M-20H	0.4	20	8.00	8.80	6.000	LRDB
PSDS6M-10H	0.8	10	8.00	9.60	6.000	LRDD

D

# FLANGED TYPE LINEAR BEARINGS

STYLE	MATERIAL
<b>SQUARE OR ROUND FLANGE</b>	<b>HOUSING &amp; BALLS - 52100 CHROME STEEL RETAINER - DELRIN</b>

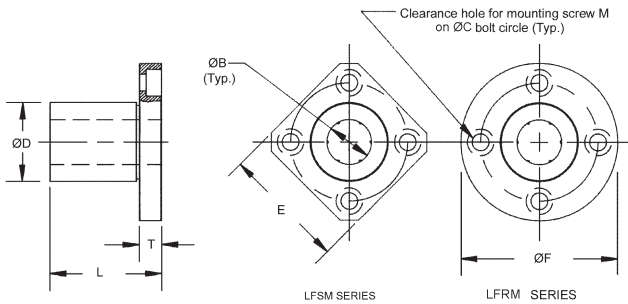

SQUARE FLANGE STOCK NO.	ROUND FLANGE STOCK NO.	WORKING BORE ØB	OUTSIDE DIA. ØC	L MAX.	T	ØF	E	ØC	M	LOAD RATING (kg)
LFSM-1	LFRM-1	6.000-0.009	12.000-0.011	19	5	28	22	20	M3	21
LFSM-2	LFRM-2	8.000-0.009	15.000-0.011	24	5	32	25	24	M3	28
LFSM-3	LFRM-3	10.000-0.009	19.000-0.013	29	6	40	30	29	M4	38
LFSM-4	LFRM-4	12.000-0.009	21.000-0.013	30	6	42	32	32	M4	42
LFSM-5	LFRM-5	13.000-0.009	23.000-0.013	32	6	43	34	33	M4	52
LFSM-6	LFRM-6	16.000-0.009	28.000-0.013	37	6	48	37	38	M4	79
LFSM-7	LFRM-7	20.000-0.010	32.000-0.019	42	8	54	42	43	M5	90
LFSM-8	LFRM-8	25.000-0.010	40.000-0.019	59	8	62	50	51	M5	100
LFSM-9	LFRM-9	30.000-0.010	45.000-0.019	64	10	74	58	69	M6	100

# LINEAR BALL BEARINGS

SHAFT SIZE	MATERIAL
6mm TO 30mm	HOUSING AND BALLS - STAINLESS STEEL OR 52100 CHROME STEEL BALL RETAINER - PLASTIC

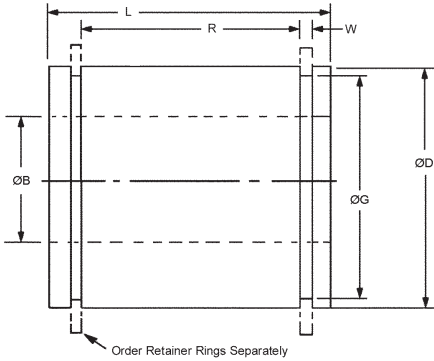

STAINLESS STEEL STOCK NO.	CHROME STEEL STOCK NO.	WORKING BORE ØB	OUTSIDE DIA. ØD	L ±0.3	R	W	ØG	RATED LOAD (kg)	RECOMMENDED FITS		SHAFT STOCK NO.	RETAINER RING STOCK NO.
									NORMAL ±0.013	PRESS ±0.013		
LMBM-1SS	LMBM-1	6.000-0.009	12-11µm	19.0	11.3	1.1	11.5	21	12.000	11.975	S416-6M-900	Q2M-12
LMBM-2SS	LMBM-2	10.000-0.009	19-13µm	29.0	19.4	1.3	18.0	38	19.000	18.975	S416-10M-900	Q2M-19
LMBM-3SS	LMBM-3	13.000-0.009	23-13µm	32.0	20.4	1.3	22.0	52	23.000	22.975	S416-13M-900	Q2M-23
LMBM-4SS	LMBM-4	20.000-0.009	32-16µm	42.0	27.3	1.6	30.5	90	32.000	31.975	S416-20M-900	Q2M-32
LMBM-5SS	LMBM-5	25.000-0.010	40-16µm	59.0	37.3	1.8	38.0	100	40.000	39.975	S416-25M-900	Q2M-40
LMBM-6SS	LMBM-6	30.000-0.010	45-16µm	64.0	40.8	1.8	43.0	160	45.000	44.975	S416-30M-900	Q2M-45

\* Specify Length Required.

D

# LINEAR BALL BEARINGS

STYLE	SHAFT SIZE	MATERIAL
<b>ADJUSTABLE DIAMETER SERIES</b>	<b>13mm TO 30mm</b>	<b>HOUSING AND BALLS - CHROME STEEL BALL RETAINER - PLASTIC</b>

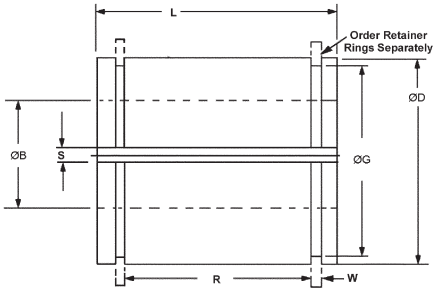

STOCK NO.	WORKING BORE (Before Adjust. ØB)	HOUSING BORE (Before Adj. ØD Ref.)	L	R ±0.3	W	ØG	RATED LOAD (kg)	MINIMUM SLOT WIDTHS	SHAFT STOCK NO.	RETAINER RING STOCK NO.
LMCM-3	13.000-0.009	23-13um	32.0	20.4	1.3	22.0	52	1.5	S416-13M-900	Q2M-23
LMCM-4	20.000-0.010	32-16um	42.0	27.3	1.6	30.5	90	1.5	S416-20M-900	Q2M-32
LMCM-5	25.000-0.010	40-16um	59.0	37.3	1.8	38.0	100	2.0	S416-25M-900	Q2M-40
LMCM-6	30.000-0.010	45-16um	64.0	40.8	1.8	43.0	160	2.5	S416-30M-900	Q2M-45

# LINEAR BALL BEARINGS SELF-ALIGNING-BARREL STYLE

SHAFT SIZE	MATERIAL
6mm TO 30mm	<b>HOUSING AND BALLS - CHROME STEEL BALL RETAINER - PLASTIC</b>

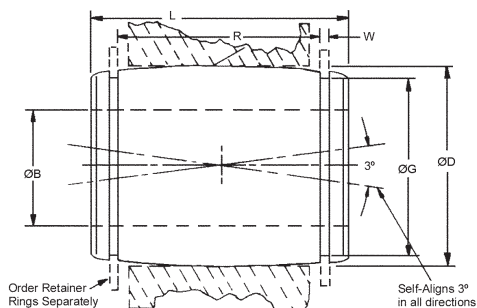

STOCK NO.	WORKING BORE ØB	HOUSING BORE ØD	L	R ±0.3	W	ØG	RATED LOAD (kg)	SHAFT STOCK NO.	RETAINER RING STOCK NO.
LMBM-1-B	6.000-0.009	12-11um	19.0	11.3	1.1	11.5	21	S416-6M-900	Q2M-12
LMBM-2-B	10.000-0.009	19-13um	29.0	19.4	1.3	18.0	38	S416-10M-900	Q2M-19
LMBM-3-B	13.000-0.009	23-13um	32.0	20.4	1.3	22.0	52	S416-13M-900	Q2M-23
LMBM-4-B	20.000-0.010	32-16um	42.0	27.3	1.6	30.5	90	S416-20M-900	Q2M-32
LMBM-5-B	25.000-0.010	40-16um	59.0	37.3	1.8	38.0	100	S416-25M-900	Q2M-40
LMBM-6-B	30.000-0.010	45-16um	64.0	40.8	1.8	43.0	160	S416-30M-900	Q2M-45

D

# LINEAR BALL BEARINGS

STYLE	SHAFT SIZE	MATERIAL
<b>OPEN SERIES</b>	<b>13mm TO 30mm</b>	<b>HOUSING AND BALLS - CHROME STEEL BALL RETAINER - PLASTIC</b>

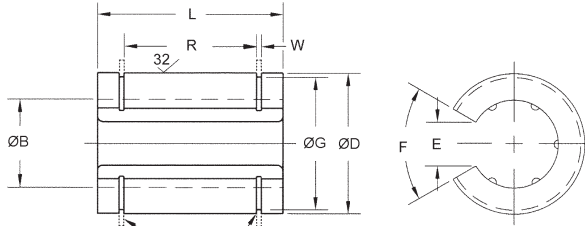

Order Retainer Ring Separately

Retainer Ring Groove



STOCK NO.	BORE (Before Adjust. ØB)	HOUSING BORE ØD (Ref.)	L	R ±0.3	W	ØG	RATED LOAD (kg)	MINIMUM SLOT		SHAFT STOCK NO.	RETAINER RING STOCK NO.
								WIDTH E	ANGLE F		
LMDM-3	13.000-0.009	23-13um	32.0	20.4	1.3	22.0	52	9	80°	S416-13M-900	Q5M-23
LMDM-4	20.000-0.010	32-16um	42.0	27.3	1.6	30.5	90	11	60°	S416-20M-900	Q5M-32
LMDM-5	25.000-0.010	40-16um	59.0	37.3	1.8	38.0	100	12	50°	S416-25M-900	Q5M-40
LMDM-6	30.000-0.010	45-16um	64.0	40.8	1.8	43.0	160	15	50°	S416-30M-900	Q5M-45



# LINEAR “NO LUBE” BEARINGS

STYLE	SHAFT SIZE	MATERIAL
<b>OPEN</b>	<b>6mm TO 30mm</b>	<b>MOLYBDENUM DISULFIDE FILLED NYLATRON</b>

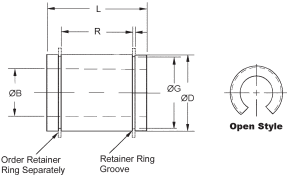

STOCK NO.	WORKING BORE ØB	OUTSIDE DIA. ØD	L	R ±0.3	W	ØG	HARDENED SHAFT STOCK NO.	SOFT ST/ST SHAFT STOCK NO.	RETAINER RING STOCK NO.
LMNM-1-OPN	6.00+0.08	12.00/-0.08	19.0	11.3	1.1	11.5	S416-6M-900	S1-106	Q2M-12
LMNM-2-OPN	10.00+0.08	19.00/-0.08	29.0	19.4	1.3	18.0	S416-10M-900	S1-110	Q2M-19
LMNM-3-OPN	13.00+0.11	23.00/-0.11	32.0	20.4	1.3	22.0	S416-13M-900	S1-113	Q2M-23
LMNM-4-OPN	20.00+0.11	32.00/-0.11	42.0	27.3	1.6	30.5	S416-20M-900	S1-120	Q2M-32
LMNM-5-OPN	25.00+0.11	40.00/-0.15	59.0	37.3	1.8	38.0	S416-25M-900	S1-125	Q2M-40
LMNM-6-OPN	30.00+0.15	45.00/-0.15	64.0	40.8	1.8	43.0	S416-30M-900	S1-130	Q2M-45

STYLE	SHAFT SIZE	MATERIAL
<b>CLOSED</b>	<b>6mm TO 30mm</b>	<b>MOLYBDENUM DISULFIDE FILLED NYLATRON</b>

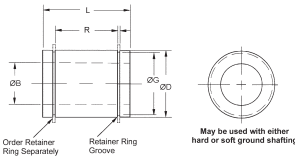

STOCK NO.	WORKING BORE ØB	OUTSIDE DIA. ØD	L	R ±0.3	W	ØG	HARDENED SHAFT STOCK NO.	SOFT ST/ST SHAFT STOCK NO.	RETAINER RING STOCK NO.
LMNM-1	6.00+0.08	12.00/-0.08	19.0	11.3	1.1	11.5	S416-6M-900	S1-106	Q2M-12
LMNM-2	10.00+0.08	19.00/-0.08	29.0	19.4	1.3	18.0	S416-10M-900	S1-110	Q2M-19
LMNM-3	13.00+0.11	23.00/-0.11	32.0	20.4	1.3	22.0	S416-13M-900	S1-113	Q2M-23
LMNM-4	20.00+0.11	32.00/-0.11	42.0	27.3	1.6	30.5	S416-20M-900	S1-120	Q2M-32
LMNM-5	25.00+0.11	40.00/-0.15	59.0	37.3	1.8	38.0	S416-25M-900	S1-125	Q2M-40
LMNM-6	30.00+0.15	45.00/-0.15	64.0	40.8	1.8	43.0	S416-30M-900	S1-130	Q2M-45

STYLE	SHAFT SIZE	MATERIAL
<b>ADJUSTABLE</b>	<b>6mm TO 30mm</b>	<b>MOLYBDENUM DISULFIDE FILLED NYLATRON</b>

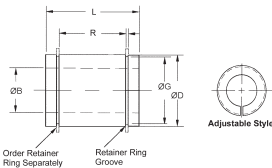

STOCK NO.	WORKING BORE ØB	OUTSIDE DIA. ØD	L	R ±0.3	W	ØG	HARDENED SHAFT STOCK NO.	SOFT ST/ST SHAFT STOCK NO.	RETAINER RING STOCK NO.
LMNM-1-ADJ	6.00+0.08	12.00/-0.08	19.0	11.3	1.1	11.5	S416-6M-900	S1-106	Q2M-12
LMNM-2-ADJ	10.00+0.08	19.00/-0.08	29.0	19.4	1.3	18.0	S416-10M-900	S1-110	Q2M-19
LMNM-3-ADJ	13.00+0.11	23.00/-0.11	32.0	20.4	1.3	22.0	S416-13M-900	S1-113	Q2M-23
LMNM-4-ADJ	20.00+0.11	32.00/-0.11	42.0	27.3	1.6	30.5	S416-20M-900	S1-120	Q2M-32
LMNM-5-ADJ	25.00+0.11	40.00/-0.15	59.0	37.3	1.8	38.0	S416-25M-900	S1-125	Q2M-40
LMNM-6-ADJ	30.00+0.15	45.00/-0.15	64.0	40.8	1.8	43.0	S416-30M-900	S1-130	Q2M-45

# SHAFT SEALS

STYLE	FOR SHAFT SIZES
<b>REGULAR</b>	<b>6mm TO 30mm</b>

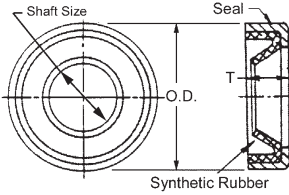

STOCK NO.	SHAFT SIZE	OUTSIDE DIA.	T
LMGM-R-5	6	12	2
LMGM-R-6	10	19	7
LMGM-R-1	13	23	7
LMGM-R-2	20	32	7
LMGM-R-3	25	40	5
LMGM-R-4	30	45	5

STYLE	FOR SHAFT SIZES
<b>ADJUSTABLE</b>	<b>6mm TO 30mm</b>

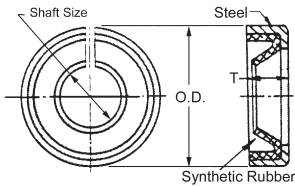

STOCK NO.	SHAFT SIZE	OUTSIDE DIA.	T
LMGM-A-5	6	12	2
LMGM-A-6	10	19	7
LMGM-A-1	13	23	7
LMGM-A-2	20	32	7
LMGM-A-3	25	40	5
LMGM-A-4	30	45	5

STYLE	FOR SHAFT SIZES
<b>OPEN</b>	<b>6mm TO 30mm</b>

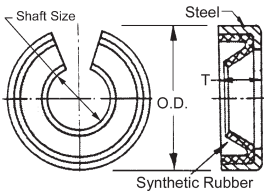

STOCK NO.	SHAFT SIZE	OUTSIDE DIA.	T
LMGM-P-5	6	12	2
LMGM-P-6	10	19	7
LMGM-P-1	13	23	7
LMGM-P-2	20	32	7
LMGM-P-3	25	40	5
LMGM-P-4	30	45	5

